

5G CPE UF51

Milesight



UF51 5G CPE is dedicated to cost effective solutions for 5G wireless networking applications. Adopting a high-performance and low power consumption industrial platform of quad-core CPU and 5G cellular module, UF51 supports the global WCDMA, 4G LTE, 5G Sub-6 GHz SA and NSA network and Wi-Fi 6, to provide ultra-fast network to ensure the extremely safe and reliable connection to the wireless network. With IP67 waterproof enclosure, various kinds of installation methods, and authentic design, UF51 is competent to both indoor and outdoor applications.

Meanwhile, UF51 also supports 2-port Gigabit Ethernet switch, RS232/RS485 serial ports and Digital input/Digital output, which enable you to scale up M2M applications combining data collection and high-speed transmission in a limited time and budget.

UF51 is particularly suitable for smart offices, video surveillance, digital media implementations, industrial automation, traffic applications, robots and so on.

◆ Fast & Reliable Network

- Industrial-grade quad-core CPU with ARM Cortex-A55 processor, providing high performance for data transmission
- Global 5G NSA&SA/4G LTE network for backup among multiple carrier networks
- Dual carrier aggregation (2CC CA) is supported in the 5G Sub-6GHz frequency band, with wider signal coverage, superb speed, and downlink speed up to 4.67 Gbps
- Plug & play, supply lightning transmission via Gigabit Ethernet ports or USB Type-C interface
- Support Wi-Fi 6, allows 2.4 GHz & 5 GHz dual band concurrent connections up to 3.6 Gbps download speed
- Embedded eight 5G antennas and four Wi-Fi antennas for best signal reception

◆ Ease of Maintenance

- DeviceHub provides easy setup, mass configuration, and centralized management of remote devices
- The user-friendly web interface design and more than one option of upgrade help administrators to manage the device as easy as pie
- Support multilevel user authorities for security management
- Fast and user-friendly programming by Node-RED development tool

◆ Robust Hardware Design

- Equipped with I/O, serial port, and GPS for industrial transmission applications
- Wide operating temperature range from -30°C to 60°C and industrial design for harsh environment
- IP67 waterproof and UV-protective enclosure for outdoor applications
- PoE, DC or USB power supply optional
- Equipped with a vent plug to prevent condensation in the enclosure
- Pole mounting, wall mounting, desktop, bottom screw mounting for various applications
- 3-year warranty included

◆ Security & Reliability

- Automated failover/failback among Ethernet, Cellular and Wi-Fi
- Secure transmission with VPN tunnels such as IPsec/OpenVPN/L2TP/PPTP
- Embeds hardware watchdog to automatically recover from various failures, ensure the highest level of availability
- Equipped with multiple security protection measures such as ACL, DMZ, SYN-Flood protection, and data filtering to ensure that the network is secured.
- Support policy routing and NAT for more secure intranet access

◆ Application Example

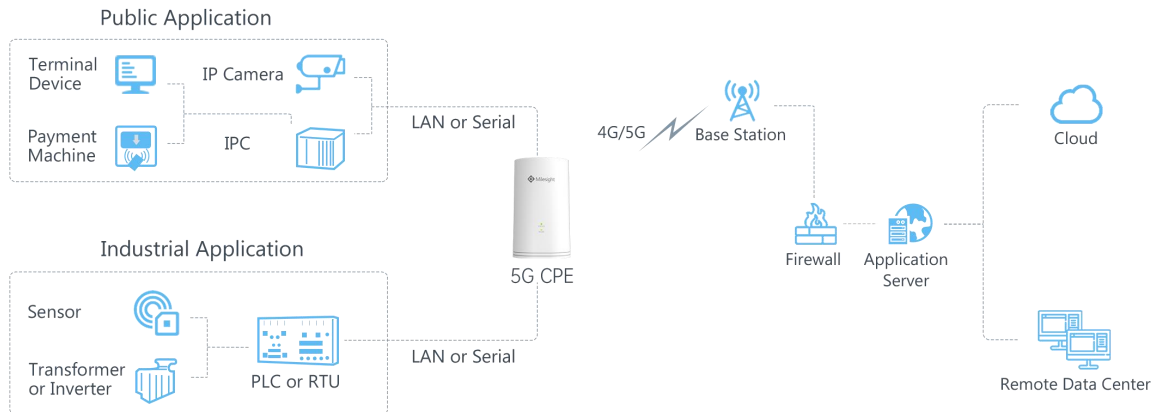

◆ Specifications

Hardware System

CPU	Quad-core ARM Cortex-A55, 2 GHz
Memory	1 GB LDDR4x RAM and 1 GB NAND Flash

Cellular Interface

Network	5G NR SA & NSA/4G LTE/WCDMA
Frequency	5G Sub-6: N1/N3/N5/N7/N8/N20/N28/N38/N40/N41/N77/N78 LTE FDD: B1/B3/B5/B7/B8/B20/B28/B32 LTE TDD: B38/B40/B41/B42/B43 WCDMA: B1/B5/B8

Antenna	8 × Internal Antennas
---------	-----------------------

SIM Slot	1 (Micro SIM-3FF)
----------	-------------------

Ethernet Interface

Numbers	1 × 10/100/1000/ Mbps (LAN2) 1 × 10/100/1000/2500 Mbps (LAN1/WAN)
Property	1 × WAN + 1 × LAN or 2 × LAN
Mode	Full or Half Duplex (Auto-Sensing)
PoE	1 × 802.3at PoE PD on LAN1/WAN Port

Wi-Fi Interface (Optional)

Antenna	4 × Internal Antennas
Standards	IEEE 802.11b/g/n/ax 4 x 4 MIMO, 2.4 GHz IEEE 802.11a/n/ac/ax 4 x 4 MIMO, 5 GHz
Max Bit Rate	2.4 GHz: 1200 Mbps, 5 GHz: 2400 Mbps

Modes	AP Mode
Security	WEP/WPA/WPA2 authentication, WEP/TKIP/AES encryption
GNSS	
Antenna	1 × Internal Antenna
Technology	GPS/GLONASS/Beidou/Galileo/QZSS
Serial Interface	
Numbers	1 × RS485 (RS232 Hardware Optional)
Connector	3.5 mm Terminal Block
Baud Rate	300bps to 230400bps
DI/DO	
Numbers	1 × DI (Dry Contact) + 1 × DO (Wet Contact), Galvanic Isolation
Connector	3.5 mm Terminal Block
Maximum V/A	0.3A@30VDC (DO)
Others	
USB	1 × USB 3.0 (Type-C) for network supply and debugging
Reset Button	1 × RESET (Internal)
LED Indicators	1 × STATUS, 1 × Cellular Network
Built-in	Watchdog, Timer
Software	
Network Protocols	IPv4/IPv6, TCP, UDP, DHCP, HTTP, HTTPS, ARP, NTP, DNS, ARP, SSH, DDNS, SNMP v3, etc.
VPN	IPsec, OpenVPN, L2TP, PPTP
Security	Access Control, DMZ, Port Forwarding, SYN-Flood Protection, Filtering (IP & MAC & Domain), IP Passthrough
Management	Web, SMS, DeviceHub, MilesightVPN
Reliability	WAN Failover
Serial Port	Transparent (TCP Client/Server, UDP), Modbus Client (Master), Modbus Gateway (Modbus RTU to Modbus TCP)
App	Node-RED
Power Supply and Consumption	
Power Connector	2-pin 3.5 mm Terminal Block
Power Input ¹	1. 9-48 VDC, with Surge-Protection and Reverse Polarity Protection 2. 802.3at PoE PD
Power Consumption	Without Wi-Fi: Typical 4.8 W, Max 6.5 W

¹ DC and PoE supply can not be used at the same time.

With Wi-Fi: Typical 9.9 W, Max 14.4 W

Physical Characteristics

Ingress Protection	IP67
Housing	Polycarbonate + Cast Aluminium
Dimension	No Waterproof Connector: $\phi 105 \times 110 \times 187$ mm ($\phi 4.13 \times 4.33 \times 7.36$ in) With Waterproof Connector: $\phi 105 \times 110 \times 218$ mm ($\phi 4.13 \times 4.33 \times 8.58$ in)
Installation	Desktop, Pole Mounting, Wall Mounting, Bottom Screw Mounting

Environmental

Operating Temperature	-30°C to $+60^{\circ}\text{C}$ (-22°F to $+140^{\circ}\text{F}$)
Storage Temperature	-40°C to $+85^{\circ}\text{C}$ (-40°F to $+185^{\circ}\text{F}$)
Ethernet Isolation	1.5 kV RMS
Relative Humidity	0% to 95% (Non-condensing) at $25^{\circ}\text{C}/77^{\circ}\text{F}$

Approvals

Regulatory	CE
Environmental	RoHS

◆ Dimensions (mm)

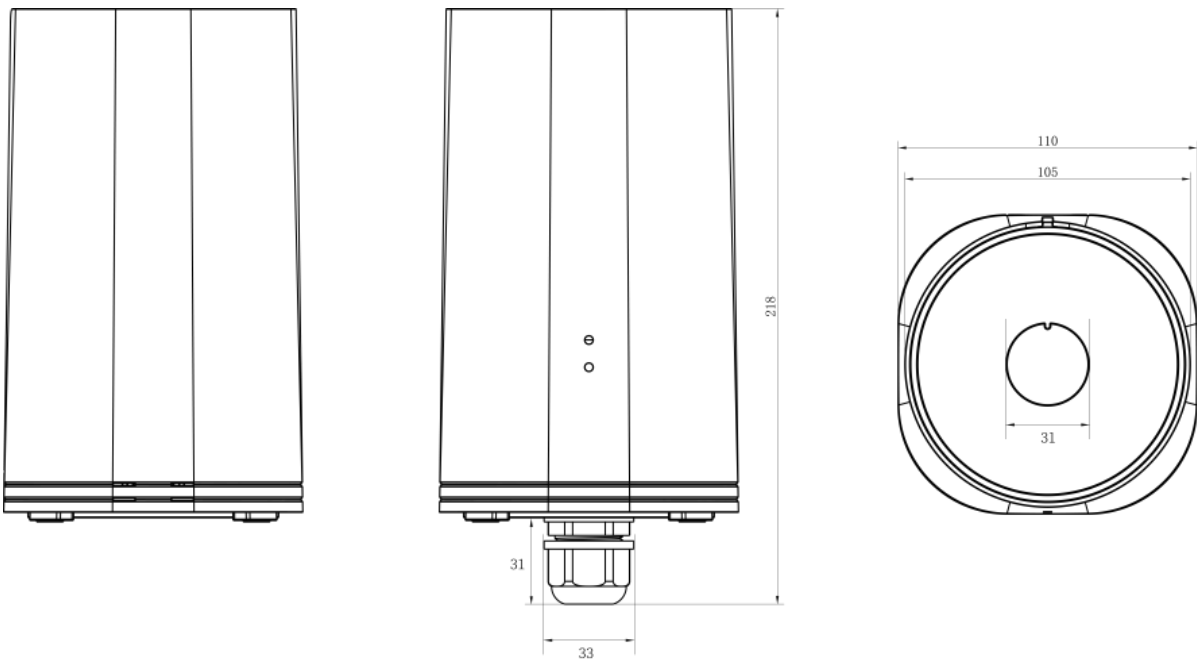

◆ Accessories

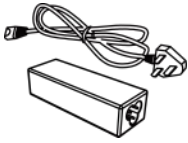

1 × PoE Injector

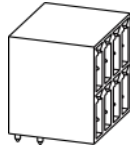

1 × 8-Pin Pluggable Terminal

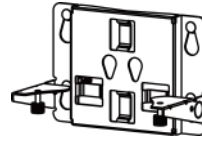

1 × Mounting Bracket

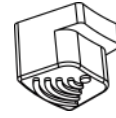

4 × Rubber Feet

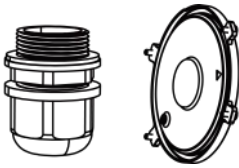

1 × Bottom Cover with Cable Gland



1 × Waterproof Rubber Ring



4 × Wall Mounting Kits



2 × Hose Clamps

***Note:** Contact us if you need any other special accessories or customized accessories.

